

## EY6IO30: 16 × DI/CI inputs I/O module, modu630-IO

### Features

- Part of the SAUTER modulo 6 system family
- Plug-in element for extending the modu660-AS and modu680-AS automation stations and the modu612-LC IP coupler
- Receiving digital inputs (alarm, status or pulse counter) in operational systems, e.g. in HVAC engineering
- 16 digital inputs
- Power supply from modu6\*\*-AS automation station, modu612-LC IP coupler or modu601-LC supply module
- Can be equipped locally with a modu600-LO operating and indicating unit



EY6IO30F001

### Technical data

<b>Power supply</b>		
Power supply		From AS or LC via I/O bus
Dissipated power <sup>1)</sup>		≤ 0.8 W
<b>Ambient conditions</b>		
Operating temperature		0...45 °C
Storage and transport temperature		-20...70 °C
Ambient humidity		10...90% rh, no condensation
<b>Inputs/outputs</b>		
Digital inputs (DI/CI)	Number of inputs	16
	Power supply for DI	Internal, ~13 VDC
	Pulse counter <sup>2)</sup>	≤ 50 Hz
<b>Interfaces, communication</b>		
	Connection, LOI	4-pin
	Connection, I/O bus	7-pin, spring contact
	Connection terminals	4 x 8-pin spring-loaded plug-in connectors
	Earth connector	Spring contact against DIN rail
<b>Construction</b>		
	Fitting	On metal DIN rail 35 x 7.5/15 as per EN 60715. DIN rail housing as per DIN 43880
	Dimensions W × H × D	56 (3 HP) × 100 × 59 mm
	Weight	130 g
<b>Standards, directives</b>		
	Type of protection	Connections and terminals:IP00 Front in DIN cut-out:IP30 (EN 60730-1)
	Protection class	I (EN 60730-1)
	Software class <sup>3)</sup>	A (EN 60730-1, Appendix H)
	Environment class	3K3 (IEC 60721)
CE/UKCA conformity <sup>4)</sup>	EMC-D 2014/30/EU (CE)	EN 50491-5-1, EN 50491-5-2, EN 50491-5-3
	EMC-2016 (UKCA)	See EMC Directive
	RoHS-D 2011/65/EU & 2015/863/EU (CE)	EN IEC 63000
	RoHS-2012 (UKCA)	EN IEC 63000

<sup>1)</sup> Measured value without accessories

<sup>2)</sup> 50 Hz only with PC module, otherwise 5 Hz

<sup>3)</sup> The product is not suitable for safety functions

<sup>4)</sup> Explanation of abbreviations in the "Further information" section of the product data sheet and in the appendix to SAUTER's product catalogues



### Overview of types

Type	Features
EY6IO30F001	16 x DI/CI inputs I/O module

### Accessories

Type	Description
EY6LO00F001	Local operating and indicating unit for I/O modules

### Manuals

Document number	Language	Title
D100397589	de	SAUTER modulo system description
D100408512	de	EY-modulo 6 – Best Practice I
D100402674	en	SAUTER modulo system description
D100410201	en	EY-modulo 6 – Best Practice I
D100402676	fr	Description du système SAUTER modulo
D100410203	fr	EY-modulo 6 – Meilleures pratiques I

## Description of operation

The modu630-IO is an I/O module for extending the modu660-AS and modu680-AS automation stations and the modu612-LC coupler.

The modu630-IO is used in operational plants (e.g. in HVAC) to record digital status and alarm inputs or digital counter pulses.

The module provides a total of 16 digital inputs.

## Intended use

This product is only suitable for the purpose intended by the manufacturer, as described in the "Description of operation" section.

All related product regulations must also be adhered to. Changing or converting the product is not admissible.

## Improper use

The SAUTER modulo 6 system does not have functional safety and is not fail-safe. MTTF, MTBF and MTTR data is not available.

This product is not suitable:

- For safety functions
- In transportation equipment and storage facilities as per Regulation 37/2005
- As a measuring device as per EU Measuring Instruments Directive 2014/32/EU
- For use outside and in rooms with a risk of condensation

## Engineering and fitting notes



### Notice

Only qualified electricians are permitted to fit and connect the module.  
Prevent access by laypersons.

The modu630-IO is a module that is connected frontally on the DIN rail. The connection between the modules is made via spring contacts on the side.

The spring contacts of the last module on the right side must be covered by the bus cover provided with the automation station.



### Note

The ground terminal must not be earthed.  
For examples and procedures for problem-free installation and wiring, see the manual "EY-modulo 6 – Best Practice I"







## Assignment to the automation station

The type and position of the I/O module in the system are defined using CASE Suite. This information is stored permanently in the automation station.

If the configuration with CASE Suite does not match the physical arrangement of the module, this is indicated by the system LED of the module.

## LED indicators

The following operating statuses of the I/O module are indicated by the front system LED:

Status <sup>5)</sup>	Indicator/display	Description
Continuous green		Normal mode
Continuous orange		Start-up mode
Flashing orange		Configuration error
Continuous red		Not configured
Flashing red		I/O bus communication error
Alternating Green → Red → Off (1 sec. each)		LED test
Off		No power supply

## Digital inputs (DI/CI)

Number of inputs	16
Type of inputs	Potential-free contacts, connected to ground Opto-coupler Transistor (open collector)
Pulse counter <sup>6)</sup>	≤ 50 Hz
Pulse status	> 4 ms
Protection against external voltage	± 30 VDC
Output current	≤ 1.5 mA
Measuring period	60 ms

### Pulse counters (CI with DI)

At the digital inputs, signals of potential-free contacts, opto-couplers or transistors with an open collector can be received. The maximum pulse frequency may be 50 Hz.

The de-bounce time can be configured so that switching contacts are correctly detected (CASE Suite: filter setting) (0...100 ms). Pulses can be captured on the falling or rising edge, or on both edges. The minimum pulse duration should be 4 times the de-bounce time.

## Technical specification of the inputs and outputs

Binary input	Switching threshold high "0"	Switching threshold low "1"	Switching hysteresis	Pulse counter
Digital input <sup>7)</sup> (DI)	≥ 4 V	≤ 1 V	0.4 V	≤ 50 Hz <sup>8)</sup>

## Channel and terminal assignment

### Digital input for pulse counter (CI)

Duct	Schematic	Terminals	
		Signal	GND
0	d0	2	1
1	d1	4	3

<sup>5)</sup> LED flashing: 500 ms on, 500 ms off

<sup>6)</sup> 50 Hz only with PC module, otherwise 5 Hz

<sup>7)</sup> Between 1 and 4 V the switching transitions are not defined

<sup>8)</sup> 50 Hz only with PC module, otherwise 5 Hz

Duct	Schematic	Terminals	
		Signal	GND
2	d2	6	5
3	d3	8	7
4	d4	10	9
5	d5	12	11
6	d6	14	13
7	d7	16	15
8	d8	17	18
9	d9	19	20
10	d10	21	22
11	d11	23	24
12	d12	25	26
13	d13	27	28
14	d14	29	30
15	d15	31	32

### Connection of the local operating and indicating unit (LOI)

The I/O module can be supplemented by the LOI modu600-LO. The LOI enables the direct control of the positioning signals and the display of the input and output signals.

The unit can be installed and removed during operation (hot-pluggable) without affecting functions of the automation station or I/O module.

For detailed information on the control function and display, see product data sheet 91.141 for the modu600-LO.

#### Note



The modu600-LO does not store any override values. When a unit is removed and inserted, the signals remain unchanged.

Override values are deleted during a firmware update.

LOIs allow limited operation of system components without the intervention of the automation station intended for the application. Outputs of the I/O modules in manual operation may change the value briefly when the user program is downloading. The LOI can be used to actuate the analogue outputs in the automation station directly even without a user application (CASE Engine).

As required by EN ISO 16484, the modu600-LO offers independent local priority operation on the IO modules when the automation station is switched off or has failed. This requires 24 VDC from the module for separate IO module supply, the modu601-LC.

Modules supplied via a modu612-LC can also benefit from local priority operation with the modu600-LO if the automation station fails.

#### Note



The modu600-LO LOI is not suitable to be used as an emergency operating device as per Machine Directive 2006/42/EU.

Standard EN ISO 13849-1 has not been considered. If applicable, a local emergency operating device must be installed on the plant side.

### Access security

#### NOTICE!



Priority operating units can lose their priority function.

► Limit the access to the local operating level (including via apps) on site.

► Consider the access security during the planning and risk assessment of the plant.

### Labelling concept

The LED display of the modu600-LO shows the individual channels as configured with CASE Suite.

### Additional information

Fitting instructions	P100017303
Declaration on materials and the environment	MD 91.111

### Abbreviations used

CE	Manufacturer's Declaration of Conformity for the European Union (EU)
UKCA	Manufacturer's Declaration of Conformity for the United Kingdom of Great Britain and Northern Ireland (UK)
EMC-D	Electromagnetic Compatibility Directive 2014/30/EU
EMC-2016	Electromagnetic Compatibility Regulations 2016 (UK)
RoHS-D	Restriction of Hazardous Substances in Electrical and Electronic Equipment Directives 2011/65/EU & 2015/863/EU
RoHS-2012	Restriction of Hazardous Substances (RoHS) Regulations 2012 (UK)

### Disposal

When disposing of the product, observe the currently applicable local laws.  
 More information on materials can be found in the Declaration on materials and the environment for this product.

### Connection diagram

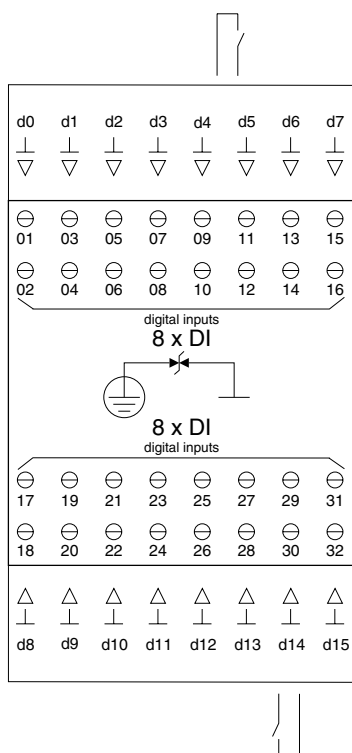

## Dimension drawing

All dimensions in mm.

