

## EY6IO31: 8 × UI (DI/CI/AI), 8 × DI/CI I/O module, modu631-IO

### Features

- Part of the SAUTER modulo 6 system family
- Plug-in element for extending the modu660-AS and modu680-AS automation stations and the modu612-LC IP coupler
- Receiving digital inputs (alarm, status or pulse counter) and analogue inputs (Ni/Pt1000, R, U) in operational systems, e.g. in HVAC
- Eight digital inputs and eight universal inputs
- Power supply from modu6\*\*-AS automation station, modu612-LC IP coupler or modu601-LC supply module
- Can be equipped locally with a modu600-LO operating and indicating unit



EY6IO31F001

### Technical data

Power supply		
	Power supply	From AS or LC via I/O bus
	Dissipated power <sup>1)</sup>	≤ 0.8 W
Ambient conditions		
	Operating temperature	0...45 °C
	Storage and transport temperature	-20...70 °C
	Ambient humidity	10...90% rh, no condensation
Inputs/outputs		
Digital inputs (DI/CI)	Number of inputs	8
	Power supply for DI	Internal, ~13 VDC
	Pulse counter	≤ 50 Hz
Universal inputs (UI)	Number of inputs	8
	Analogue	U: 0(2)...10 V Ni1000, Pt1000 R: 200...2500 Ω
	Digital <sup>2)</sup>	DI/CI: ≤ 50 Hz
Interfaces, communication		
	Connection, LOI	4-pin
	Connection, I/O bus	7-pin, spring contact
	Connection terminals	4 x 8-pin spring-loaded plug-in connectors
	Earth connector	Spring contact against DIN rail
Construction		
	Fitting	On metal DIN rail 35 x 7.5/15 as per EN 60715. DIN rail housing as per DIN 43880
	Dimensions W × H × D	56 (3 HP) × 100 × 59 mm
	Weight	131 g
Standards, directives		
	Type of protection	Connections and terminals: IP00 Front in DIN cut-out: IP30   (EN 60730-1)
	Protection class	I (EN 60730-1)
	Software class <sup>3)</sup>	A (EN 60730-1, Appendix H)
	Environment class	3K3 (IEC 60721)

<sup>1)</sup> Measured value without accessories

<sup>2)</sup> DI: 50 Hz only with PC module, otherwise 5 Hz

<sup>3)</sup> The product is not suitable for safety functions



CE/UKCA conformity <sup>4)</sup>	EMC-D 2014/30/EU (CE)	EN 50491-5-1, EN 50491-5-2, EN 50491-5-3
	EMC-2016 (UKCA)	See EMC Directive
	RoHS-D 2011/65/EU & 2015/863/EU (CE)	EN IEC 63000
	RoHS-2012 (UKCA)	EN IEC 63000

#### Overview of types

Type	Features
EY6IO31F001	8 x UI(DI/CI/AI) and 8 x DI/CI I/O module

#### Accessories

Type	Description
EY6LO00F001	Local operating and indicating unit for I/O modules

#### Manuals

Document number	Language	Title
D100397589	de	Systembeschreibung SAUTER modulo
D100408512	de	EY-modulo 6 – Best Practice I
D100402674	en	SAUTER modulo system description
D100410201	en	EY-modulo 6 – Best Practice I
D100402676	fr	Description du système SAUTER modulo
D100410203	fr	EY-modulo 6 – Meilleures pratiques I

### Description of operation

The modu631-IO is an I/O module for extending the modu660-AS and modu680-AS automation stations and the modu612-LC coupler.

The modu631-IO serves the following purposes in operational plants (e.g. in HVAC):

- Receiving digital, status, alarm and pulse counter inputs
- Receiving analogue inputs (Ni/Pt1000, R, U)

The module provides eight digital and eight universal inputs.

### Intended use

This product is only suitable for the purpose intended by the manufacturer, as described in the "Description of operation" section.

All related product regulations must also be adhered to. Changing or converting the product is not admissible.

### Improper use

The SAUTER modulo 6 system does not have functional safety and is not fail-safe. MTTF, MTBF and MTTR data is not available.

This product is not suitable:

- For safety functions
- In transportation equipment and storage facilities as per Regulation 37/2005
- As a measuring device as per EU Measuring Instruments Directive 2014/32/EU
- For use outside and in rooms with a risk of condensation

### Engineering and fitting notes



#### Notice

Only qualified electricians are permitted to fit and connect the module.  
Prevent access by laypersons.

The modu630-IO is a module that is connected frontally on the DIN rail. The connection between the modules is made via spring contacts on the side.

The spring contacts of the last module on the right side must be covered by the bus cover provided with the automation station.

<sup>4)</sup> Explanation of abbreviations in the "Further information" section of the product data sheet and in the appendix to SAUTER's product catalogues

**Note**

The ground terminal must not be earthed.

For examples and procedures for problem-free installation and wiring, see the manual "EY-modulo 6 – Best Practice I"







**Assignment to the automation station**

The type and position of the I/O module in the system are defined using CASE Suite. This information is stored permanently in the automation station.

If the configuration with CASE Suite does not match the physical arrangement of the module, this is indicated by the system LED of the module.

**LED indicators**

The following operating statuses of the I/O module are indicated by the front system LED:

Status <sup>5)</sup>	Indicator/display	Description
Continuous green		Normal mode
Continuous orange		Start-up mode
Flashing orange		Configuration error
Continuous red		Not configured
Flashing red		I/O bus communication error
Alternating Green → Red → Off (1 sec. each)		LED test
Off		No power supply

**Digital inputs (DI/CI)**

Number of inputs	8
Type of inputs	Potential-free contacts, connected to ground Opto-coupler Transistor (open collector)
Pulse counter <sup>6)</sup>	≤ 50 Hz
Pulse status	> 4 ms
Protection against external voltage	± 30 VDC
Output current	≤ 1.5 mA
Measuring period	60 ms

**Pulse counters (CI with DI)**

At the digital inputs, signals of potential-free contacts, opto-couplers or transistors with an open collector can be connected. The maximum pulse frequency may be 50 Hz.

The de-bounce time can be configured so that switching contacts are correctly detected (CASE Suite: filter setting) (0...100 ms). Pulses can be captured on the falling or rising edge, or on both edges. The minimum pulse duration should be 4 times the de-bounce time.

<sup>5)</sup> LED flashing: 500 ms on, 500 ms off

<sup>6)</sup> 50 Hz only with PC module, otherwise 5 Hz

## Universal inputs (UI)

Number of inputs	8	
Type of inputs (software coding)	Temperature, Ni1000 (DIN 43760)	
	Temperature, Pt1000 (EN 60751)	
	Resistance (R)	
	Voltage measurement (U)	
	Digital input (DI/CI)	
Protection against external voltage	Ni/Pt1000	± 30 VDC
	R	± 30 VDC
	U, 0...10 V	± 30 VDC
	DI	± 30 VDC
Measuring period	Ni/Pt1000	1250 ms
	R	1250 ms
	U, 0...10 V	200 ms
Resolution	12 bit ADC oversampled to 14 bit	
	Ni/Pt1000	0.02 K
	R	0.1 Ω
	U, 0...10 V	1 mV
Measuring ranges	Temperature, Ni1000	-50...185 °C
	Temperature, Pt1000	-50...185 °C
	Resistance (R)	200...2500 Ω
	Voltage (U)	0.1...11.4 V
Digital input	Pulse counter	≤ 50 Hz
	Overview of pulse recording firmware module	Potential-free contacts with ground connection, opto-coupler, transistor (open collector) approx. $I_{out} \leq 1.5$ mA
	BI	≤ 5 Hz
	PC	≤ 50 Hz

### Temperature measurement (Ni/Pt)

The Ni1000 sensors (DIN 43760, TK5000) and Pt1000 sensors (EN 60751) are connected using two wires between one of the input terminals for universal inputs (channels u8...u15) and the corresponding ground terminal.

The inputs require no calibration and can be used directly. A line resistance of 2 Ω is pre-compensated as standard. With a cable cross-section of 1.5 mm<sup>2</sup>, the maximum length of the connecting cable is therefore 85 m. Larger line resistances can be compensated by the software. The measurement current is pulsed so that the sensor is not heated up.

### Voltage measurement (U)

The connection for voltage measurement is made between an input terminal (channels u8...u15) and the corresponding ground terminal.

The measuring ranges with or without offset 0(2)...10 V are selected using the CASE software.

0(4)...20 mA signals can be converted into 0(2)...10 V signals using 500 Ω resistors (directly on the terminals).

### Digital inputs (DI/CI with UI)

The automation station also records binary information with the universal inputs. The information (alarm and status) is connected between an input terminal (channels u8...u15) and the related ground terminal.

The module applies a voltage of > 9.5 V to the terminal. If a contact is open, this usually corresponds to an *inactive* state (bit = 0). If a contact is closed, there is an *active* state (bit = 1) and 0 V is applied, giving a current of approximately 1.5 mA.

Every input can be defined individually as an alarm, status or pulse counter by setting software parameters. The digital inputs can be displayed with the modu600-LO local operating and indicating unit.

At the universal inputs, signals of potential-free contacts, opto-couplers or transistors with an open collector can be connected.

## Technical specification of the inputs and outputs

Universal input (UI)	Measuring range	Resolution	Accuracy <sup>7)</sup>
Ni/Pt1000	-50...+185 °C	0.02 K	Ni1000: ± 1.7 K ± 1.0 K (measured value: 15...30 °C) Pt1000: ± 2.9 K ± 1.6 K (measured value: 15...30 °C)
R	200...2500 Ω	0.1 Ω	± 13 Ω
U, 0...10 V	0.1...11.4 V	1 mV	± 0.03 V

Binary input	Switching threshold high "0"	Switching threshold low "1"	Switching hysteresis	Pulse counter <sup>8)</sup>
Digital input (DI)	4 V	1 V	0.4 V	≤ 50 Hz
Universal input (UI)	4 V	1 V	0.4 V	≤ 50 Hz

## Channel and terminal assignment

### Digital input for pulse counter (DI/CI)

Duct	Schematic	Terminals	
		Signal	GND
0	d0	2	1
1	d1	4	3
2	d2	6	5
3	d3	8	7
4	d4	10	9
5	d5	12	11
6	d6	14	13
7	d7	16	15

### Universal input (Ni/Pt1000, R, U, DI/CI)

Duct	Schematic	Terminals	
		Signal	GND
8	u8	17	18
9	u9	19	20
10	u10	21	22
11	u11	23	24
12	u12	25	26
13	u13	27	28
14	u14	29	30
15	u15	31	32

## Connection of the local operating and indicating unit (LOI)

The I/O module can be supplemented by the LOI modu600-LO. The LOI enables the direct control of the positioning signals and the display of the input and output signals.

The unit can be installed and removed during operation (hot-pluggable) without affecting functions of the automation station or I/O module.

For detailed information on the control function and display, see product data sheet 91.141 for the modu600-LO.

### Note



The modu600-LO does not store any override values. When a unit is removed and inserted, the signals remain unchanged.

Override values are deleted during a firmware update.

<sup>7)</sup> At an I/O module temperature of 25 °C

<sup>8)</sup> 50 Hz only with PC module, otherwise 5 Hz

LOIs allow limited operation of system components without the intervention of the automation station intended for the application. Outputs of the I/O modules in manual operation may change the value briefly when the user program is downloading. The LOI can be used to actuate the analogue outputs in the automation station directly even without a user application (CASE Engine).

As required by EN ISO 16484, the modu600-LO offers independent local priority operation on the IO modules when the automation station is switched off or has failed. This requires 24 VDC from the module for separate IO module supply, the modu601-LC.

Modules supplied via a modu612-LC can also benefit from local priority operation with the modu600-LO if the automation station fails.

#### Note



The modu600-LO LOI is not suitable to be used as an emergency operating device as per Machine Directive 2006/42/EU.

Standard EN ISO 13849-1 has not been considered. If applicable, a local emergency operating device must be installed on the plant side.

#### Access security

##### NOTICE!



Priority operating units can lose their priority function.

- ▶ Limit the access to the local operating level (including via apps) on site.
- ▶ Consider the access security during the planning and risk assessment of the plant.

#### Labelling concept

The LED display of the modu600-LO shows the individual channels as configured with CASE Suite.

#### Additional information

Fitting instructions	P100017303
Declaration on materials and the environment	MD 91.116

#### Abbreviations used

CE	Manufacturer's Declaration of Conformity for the European Union (EU)
UKCA	Manufacturer's Declaration of Conformity for the United Kingdom of Great Britain and Northern Ireland (UK)
EMC-D	Electromagnetic Compatibility Directive 2014/30/EU
EMC-2016	Electromagnetic Compatibility Regulations 2016 (UK)
RoHS-D	Restriction of Hazardous Substances in Electrical and Electronic Equipment Directives 2011/65/EU & 2015/863/EU
RoHS-2012	Restriction of Hazardous Substances (RoHS) Regulations 2012 (UK)

#### Disposal

When disposing of the product, observe the currently applicable local laws.

More information on materials can be found in the Declaration on materials and the environment for this product.

### Connection diagram

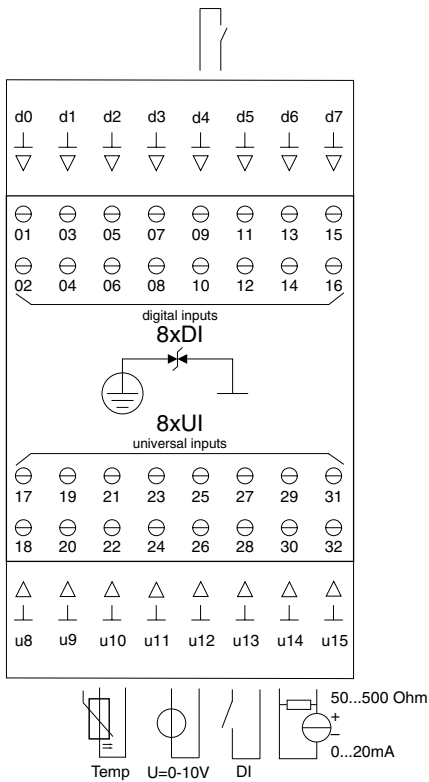

### Dimension drawing

All dimensions in mm.

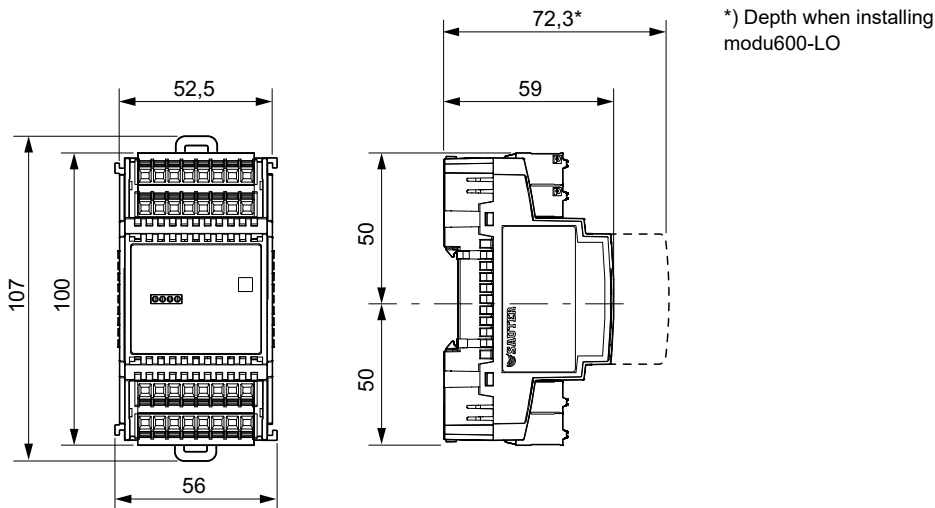

Fr. Sauter AG  
 Im Surinam 55  
 CH-4058 Basel  
 Tel. +41 61 - 695 55 55  
 www.sauter-controls.com